

TETŐBOX - ÁLTALÁNOS FELSZERELÉSI, BIZTONSÁGI ÉS BALESETVÉDELMI UTASÍTÁS ÉS TÁJÉKOZTATÁS

Kölcsönző neve: Komlószy Zoltán e.v.
Cím: 2837 Vértesszőlős, Gagarin utca 18.
Telefonszáma: +36 70 940 38 48
Adószám: 69977680-1-31
Nyilvántartási szám: 53960056



- Tetőboxal a maximális sebességhatár 120 km/h
- A gépjármű magassága megváltozik!
- A gépjármű hossza megváltozik! (vonóhorgos kerékpárszállítónál!)
- Soha ne terhelje túl a tetőboxot, kerékpárszállítót, tetőcsomagtartót!
- Megváltozott gépjármű menetdinamika

TILOS a tetőboxban:

- ⊗ állatot szállítani
- ⊗ embert szállítani
- ⊗ tűz és robbanásveszélyes anyagot szállítani (folyékony grillgyújtót és aeroszolos flakont se!)
- ⊗ építőanyagot szállítani

A tetőboxban a csomagokat minden esetben kötelező lerögzíteni!

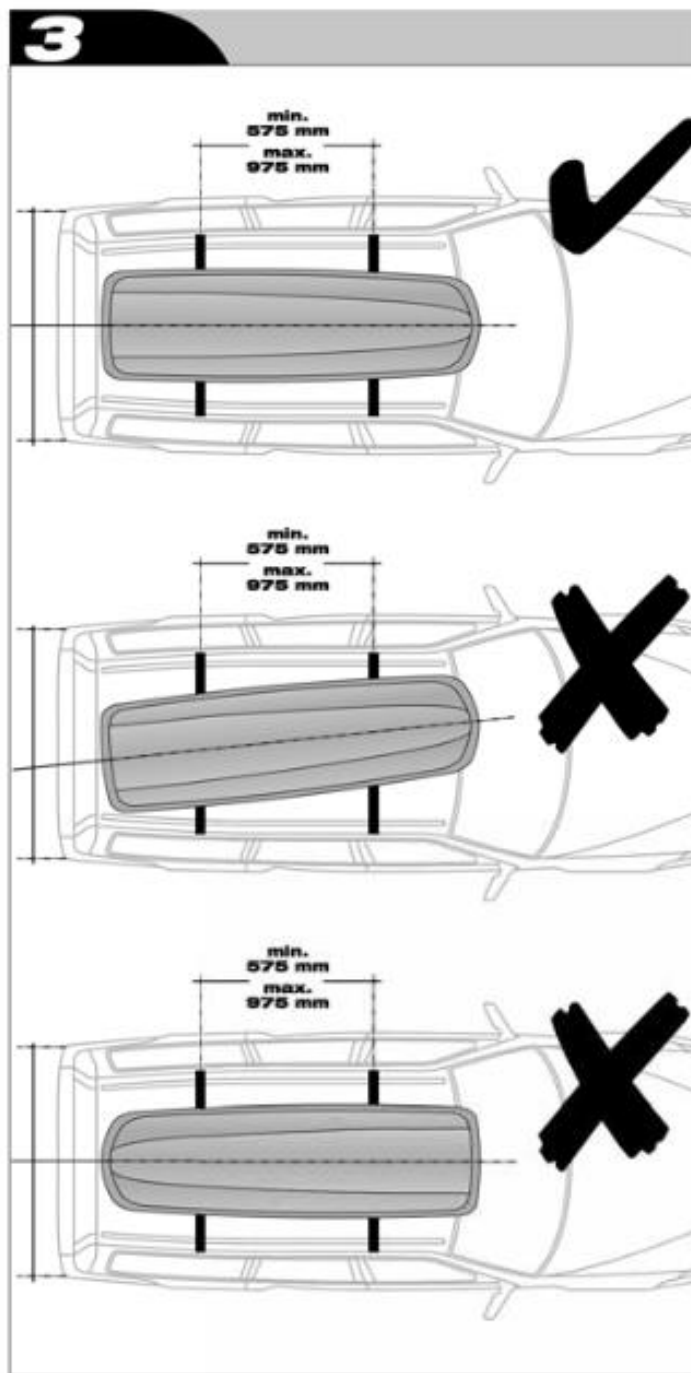
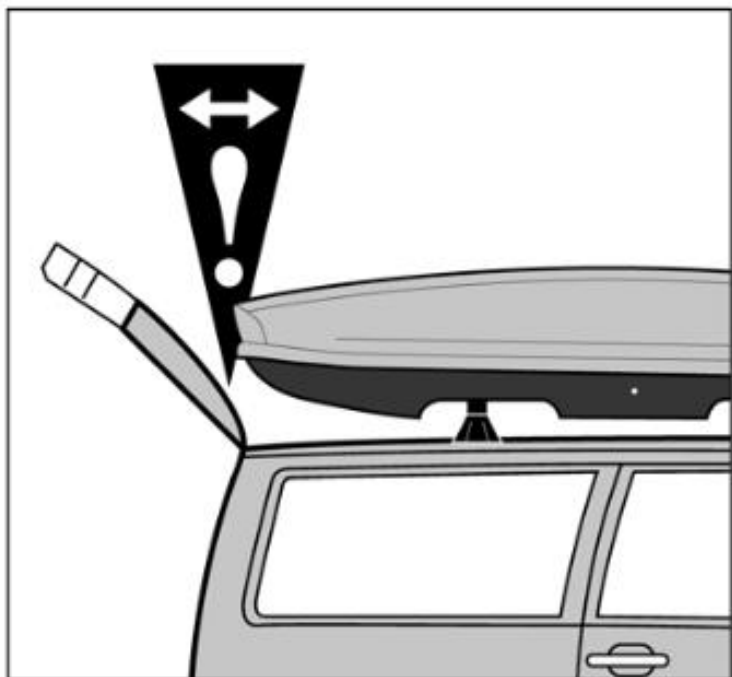
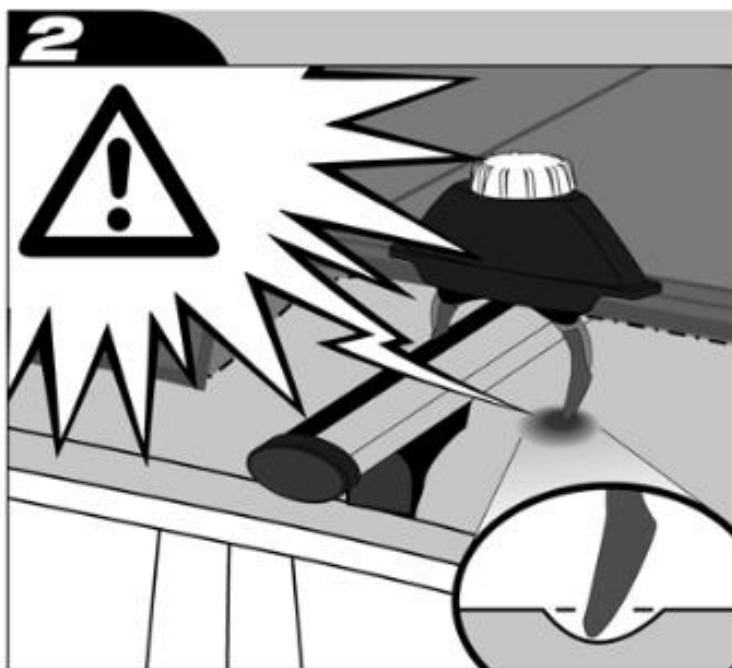
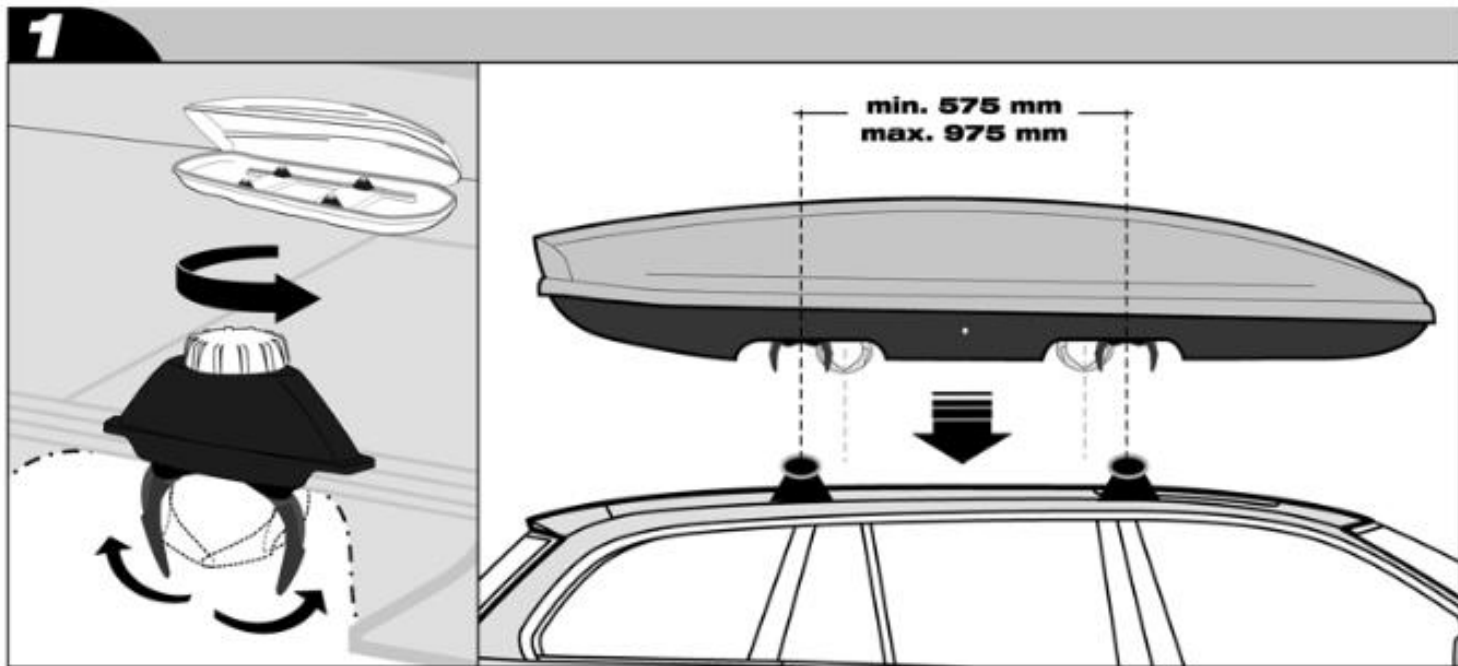

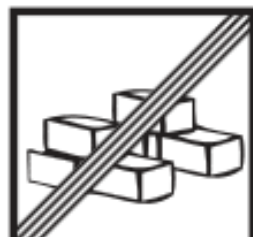
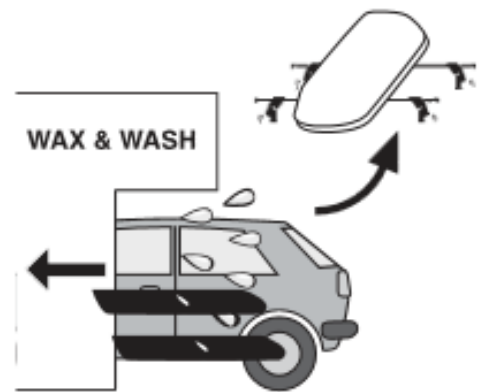
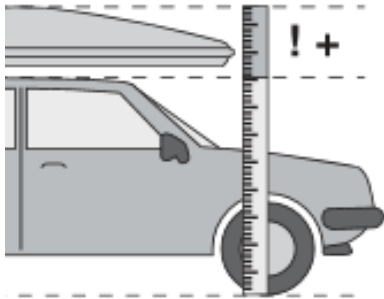
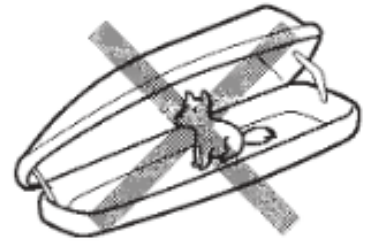
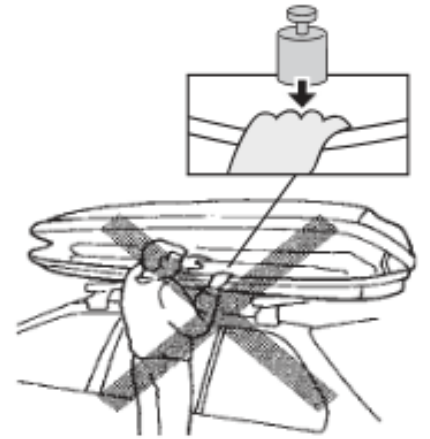
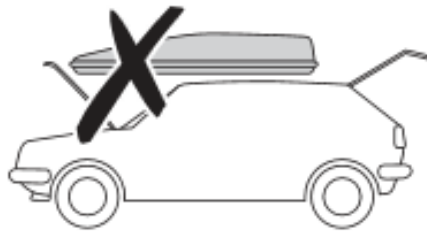

4

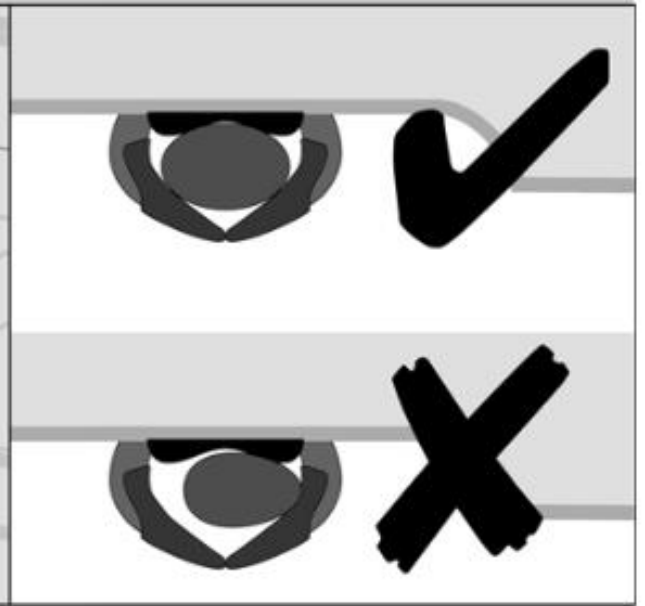
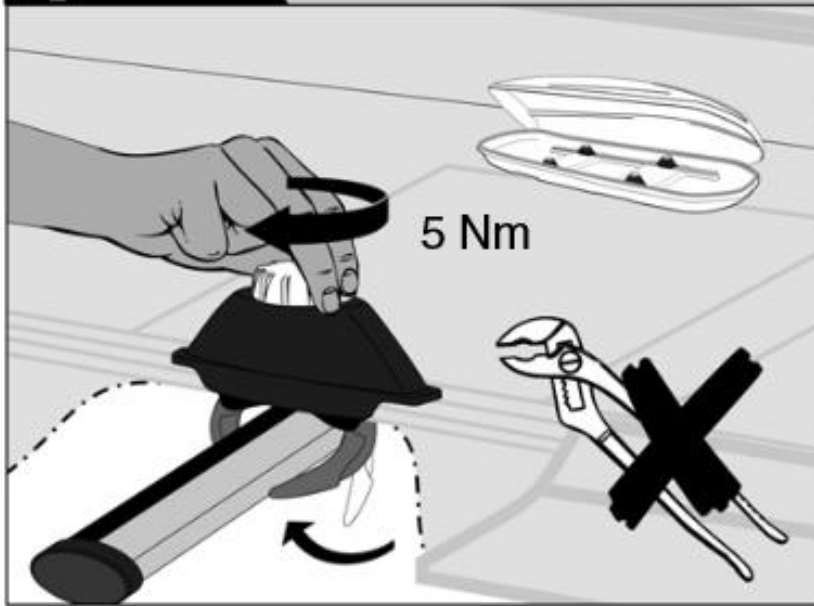

5

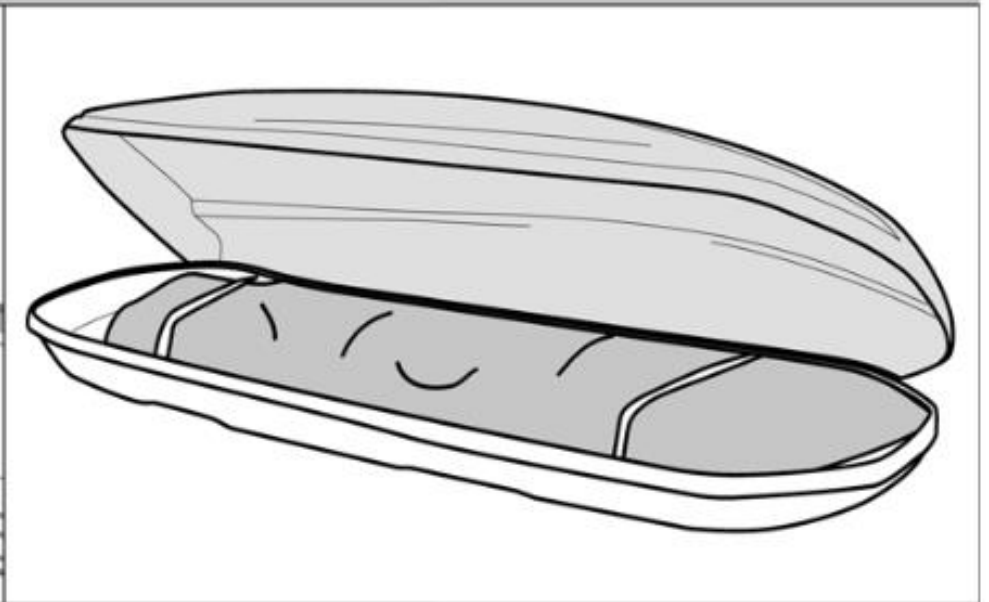
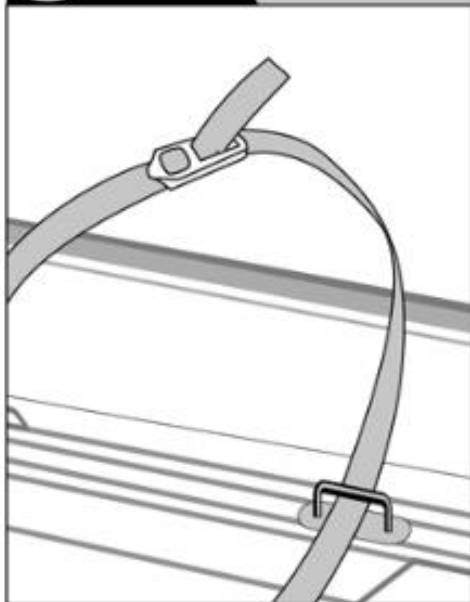

6

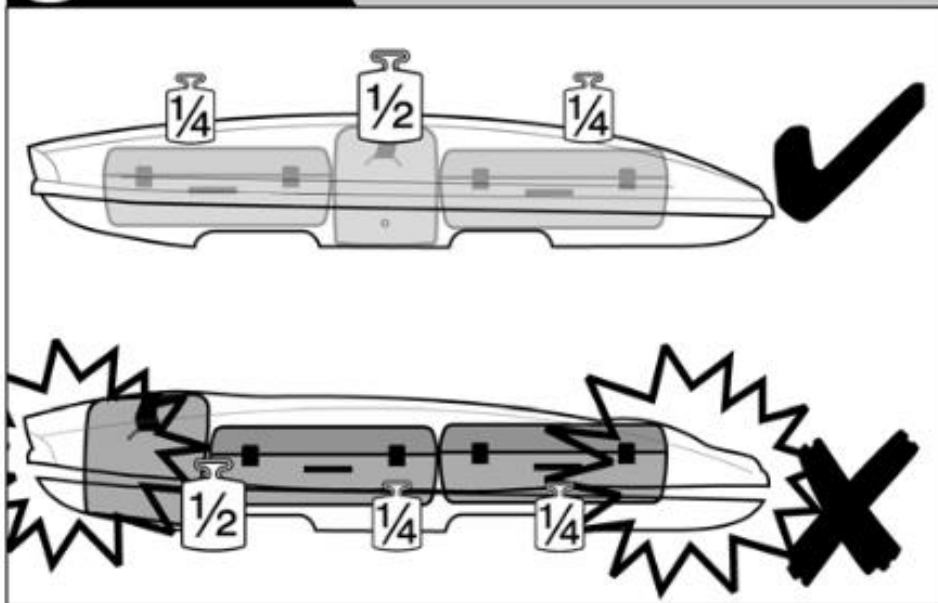

7

